

# HLMP-EGxx, HLMP-ELxx

T-1 $\frac{3}{4}$  (5 mm) High Brightness AlInGaP Red and Amber LEDs



## Data Sheet



Lead (Pb) Free  
RoHS 6 fully  
compliant



### Description

These High Brightness AlInGaP LEDs provide superior light output for excellent readability in sunlight and are extremely reliable. AlInGaP LED technology provides extremely stable light output over long periods of time. Precision Optical Performance lamps utilize the aluminum indium gallium phosphide (AlInGaP) technology.

These LED lamps are untinted. T-1 $\frac{3}{4}$  packages incorporating second generation optics producing well defined spatial radiation patterns at specific viewing cone angles.

These lamps are made with an advanced optical grade epoxy offering superior high temperature and high moisture resistance performance in outdoor signal and sign application. The epoxy contains uv inhibitor to reduce the effects of long term exposure to direct sunlight.

### Benefits

- Superior performance for outdoor environment

### Features

- Viewing angle: 15°, 23° and 30°
- Well defined spatial radiation pattern
- High brightness material
- Available in Red and Amber
  - Red AlInGaP 621 nm
  - Amber AlInGaP 590 nm
- Superior resistance to moisture
- Package options:
  - With and without standoff

### Applications

- Traffic management:
  - Traffic signals
  - Pedestrian signals
  - Work zone warning lights
  - Variable message signs
- Solar Power signs
- Commercial outdoor advertising
  - Signs
  - Marquee

## Package Dimension

### A: Non-standoff

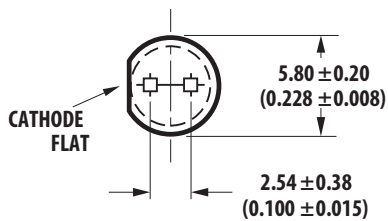
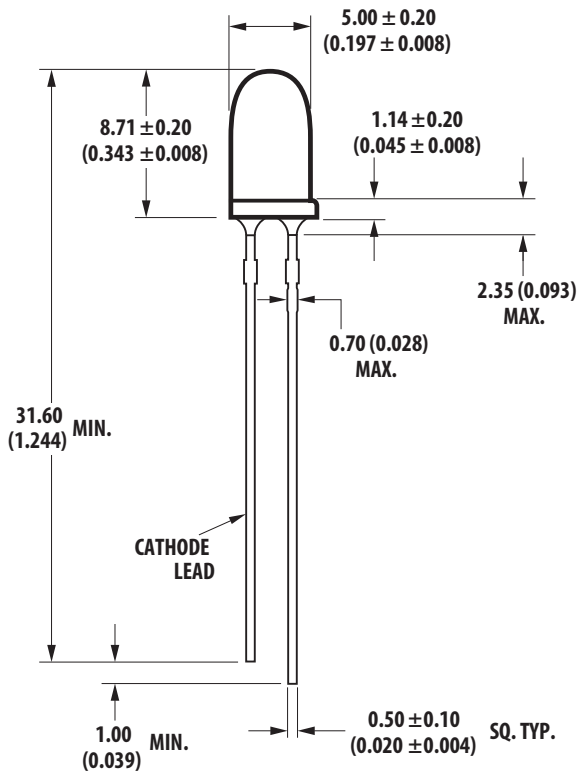

### B: Standoff

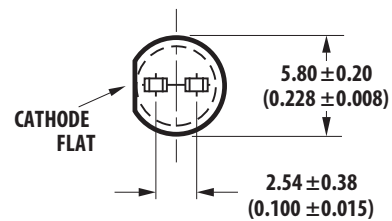
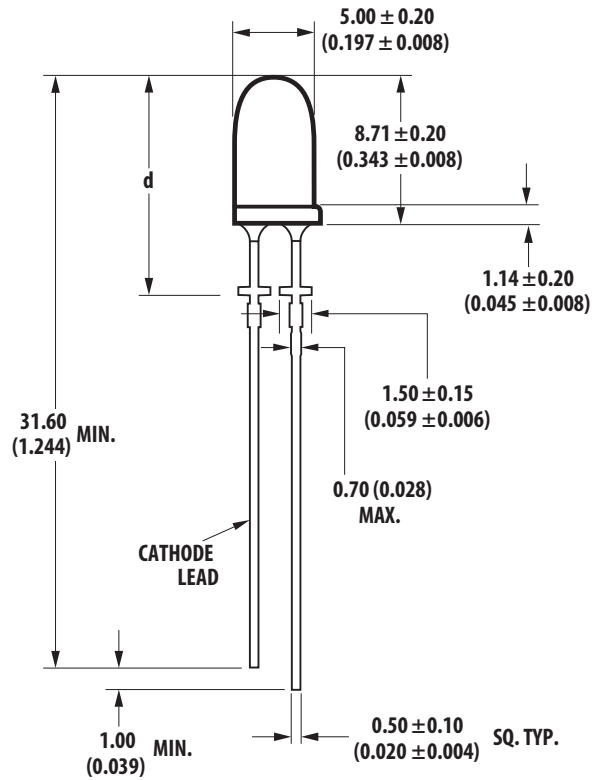

Part Number	Dimension 'd'
HLMP-Ex1T	13.03 ± 0.25
HLMP-Ex2T	12.73 ± 0.25
HLMP-Ex3T	12.26 ± 0.25

#### Notes:

1. All dimensions in millimeters (inches).
2. Tolerance is  $\pm 0.20$  mm unless other specified.
3. Leads are mild steel with tin plating.
4. The epoxy meniscus is 1.21 mm max.
5. For identification of polarity after the leads are trimmed off, please refer to the illustration below:

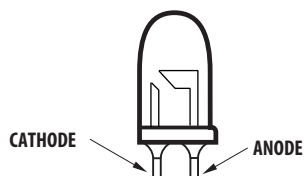

## Device Selection Guide

Part Number	Color and Dominant Wavelength $\lambda_d$ (nm) Typ <sup>[3]</sup>	Luminous Intensity Iv (mcd) at 20 mA <sup>[1,2,5]</sup>		Standoff	Typical Viewing angle (°) <sup>[4]</sup>
		Min	Max		
HLMP-EG1S-Z20DD	Red 621	12000	27000	No	15
HLMP-EG1T-Z20DD	Red 621	12000	27000	Yes	
HLMP-EL1S-Z20DD	Amber 590	12000	27000	No	
HLMP-EL1S-Z2KDD	Amber 590	12000	27000	No	
HLMP-EL1S-Z2LDD	Amber 590	12000	27000	No	
HLMP-EL1T-Z20DD	Amber 590	12000	27000	Yes	
HLMP-EL1T-Z2KDD	Amber 590	12000	27000	Yes	
HLMP-EL1T-Z2LDD	Amber 590	12000	27000	Yes	
HLMP-EG2S-XZ0DD	Red 621	7200	16000	No	
HLMP-EG2T-XZ0DD	Red 621	7200	16000	Yes	
HLMP-EL2S-XZ0DD	Amber 590	7200	16000	No	
HLMP-EL2S-XZKDD	Amber 590	7200	16000	No	
HLMP-EL2S-XZLDD	Amber 590	7200	16000	No	
HLMP-EL2T-XZ0DD	Amber 590	7200	16000	Yes	
HLMP-EL2T-XZKDD	Amber 590	7200	16000	Yes	
HLMP-EL2T-XZLDD	Amber 590	7200	16000	Yes	
HLMP-EG3S-VX0DD	Red 621	4200	9300	No	30
HLMP-EG3T-VX0DD	Red 621	4200	9300	Yes	
HLMP-EL3S-VX0DD	Amber 590	4200	9300	No	
HLMP-EL3S-VXKDD	Amber 590	4200	9300	No	
HLMP-EL3S-VXLDD	Amber 590	4200	9300	No	
HLMP-EL3T-VX0DD	Amber 590	4200	9300	Yes	
HLMP-EL3T-VXKDD	Amber 590	4200	9300	Yes	
HLMP-EL3T-VXLDD	Amber 590	4200	9300	Yes	

### Notes:

1. The luminous intensity is measured on the mechanical axis of the lamp package and it is tested with pulsing condition.
2. The optical axis is closely aligned with the package mechanical axis.
3. Dominant wavelength,  $\lambda_d$ , is derived from the CIE Chromaticity Diagram and represents the color of the lamp.
4.  $\theta_{1/2}$  is the off-axis angle where the luminous intensity is half the on-axis intensity.
5. Tolerance for each bin limit is  $\pm 15\%$

## Part Numbering System

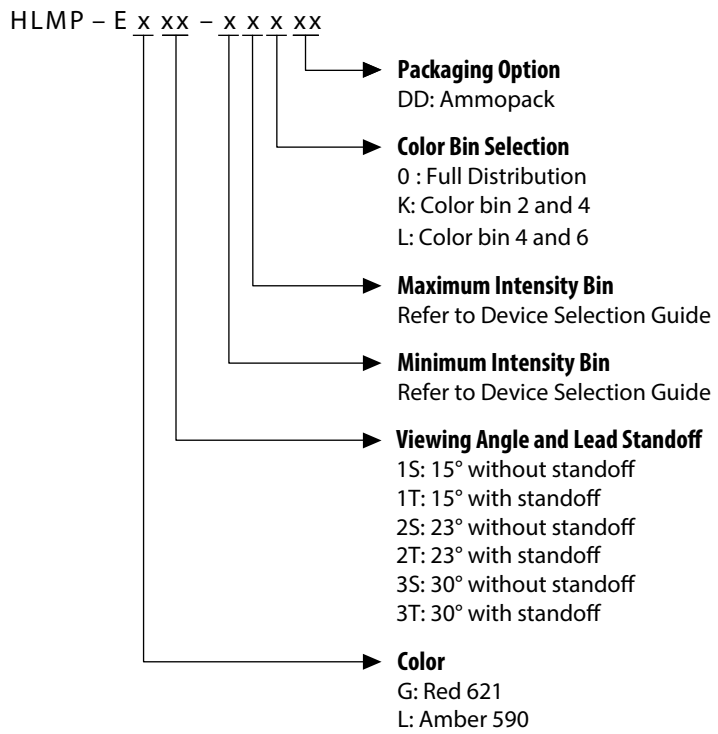

Note: Refer to AB 5337 for complete information on the part numbering system.

**Absolute Maximum Ratings  $T_J = 25^\circ\text{C}$** 

Parameter	Red/ Amber	Unit
DC Forward Current <sup>[1]</sup>	50	mA
Peak Forward Current	100 <sup>[2]</sup>	mA
Power Dissipation	120	mW
LED Junction Temperature	130	$^\circ\text{C}$
Operating Temperature Range	-40 to +100	$^\circ\text{C}$
Storage Temperature Range	-40 to +100	$^\circ\text{C}$

Notes:

1. Derate linearly as shown in Figure 4.
2. Duty Factor 30%, frequency 1 kHz.

**Electrical / Optical Characteristics  $T_J = 25^\circ\text{C}$** 

Parameter	Symbol	Min.	Typ.	Max.	Units	Test Conditions
Forward Voltage Amber/Red	$V_F$	1.8	2.1	2.4	V	$I_F = 20\text{ mA}$
Reverse Voltage <sup>[1]</sup>	$V_R$	5			V	$I_R = 100\ \mu\text{A}$
Dominant Wavelength <sup>[2]</sup> Amber Red	$\lambda_d$	587.0 618.0	590.0 621.0	594.5 630.0	nm	$I_F = 20\text{ mA}$
Peak Wavelength Amber Red	$\lambda_{PEAK}$		594 629		nm	Peak of Wavelength of Spectral Distribution at $I_F = 20\text{ mA}$
Thermal resistance	$R\theta_{J-PIN}$		240		$^\circ\text{C}/\text{W}$	LED junction to pin
Luminous efficacy <sup>[3]</sup> Amber Red	$\eta_v$		500 205		lm/W	Emitted Luminous Flux/ Emitted Radiant Flux

Notes:

1. Indicates product final testing condition, long term reverse bias is not recommended.
2. The dominant wavelength is derived from the Chromaticity Diagram and represents the color of the lamp.
3. The radiant intensity,  $I_e$  in watts per steradian, maybe found from the equation  $I_e = I_v / \eta_v$  where  $I_v$  is the luminous intensity in candela and  $\eta_v$  is the luminous efficacy in lumens/watt.

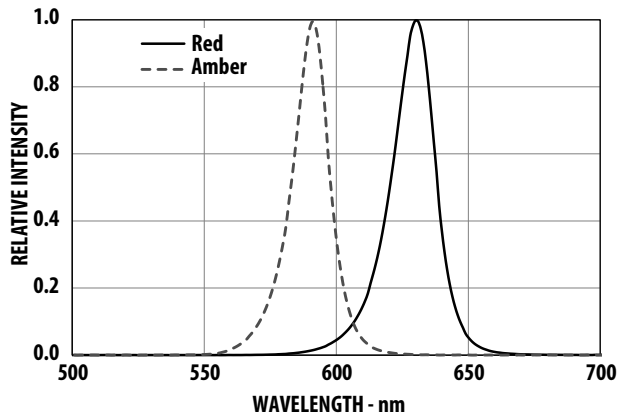

Figure 1. Relative Intensity vs Wavelength

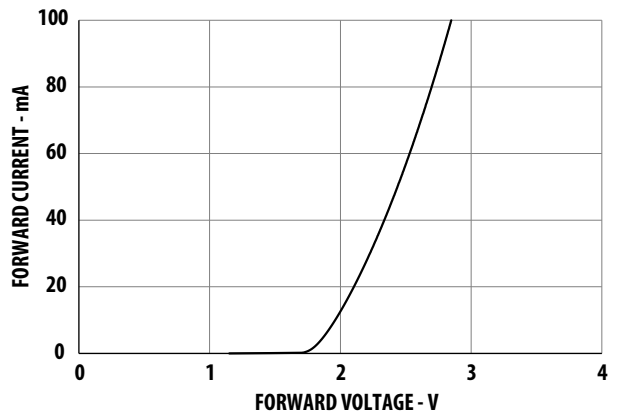

Figure 2. Forward Current vs Forward Voltage

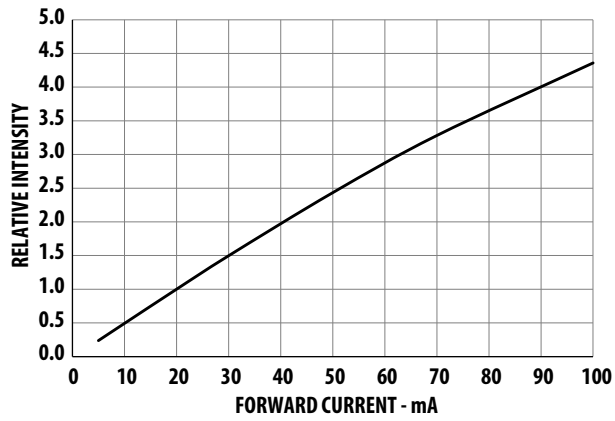

Figure 3. Relative Intensity vs Forward Current

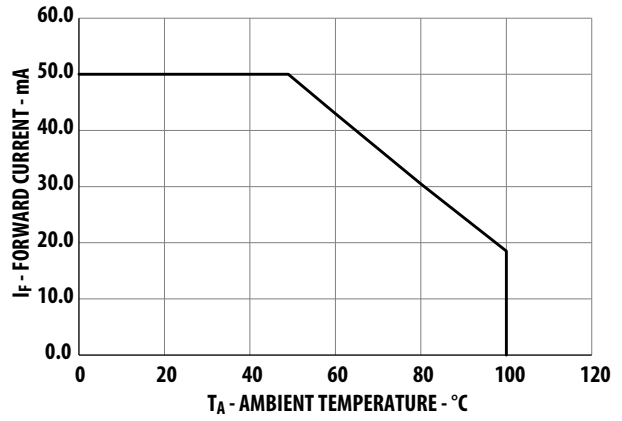

Figure 4. Maximum Forward Current vs Ambient Temperature

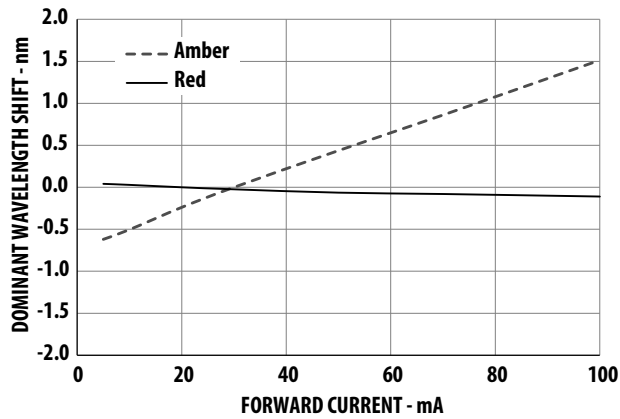

Figure 5. Dominant Wavelength Shift vs Forward Current

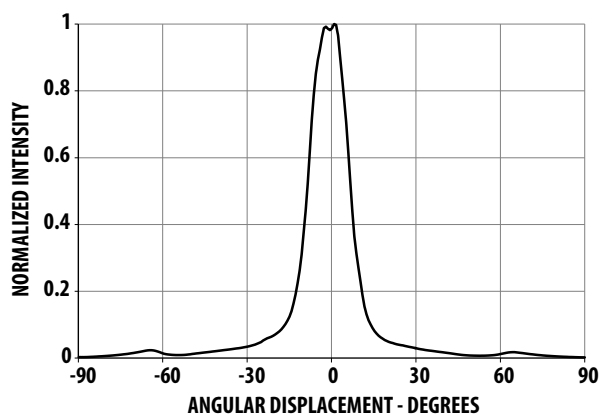

Figure 6. Representative Radiation Pattern for 15° Lamp

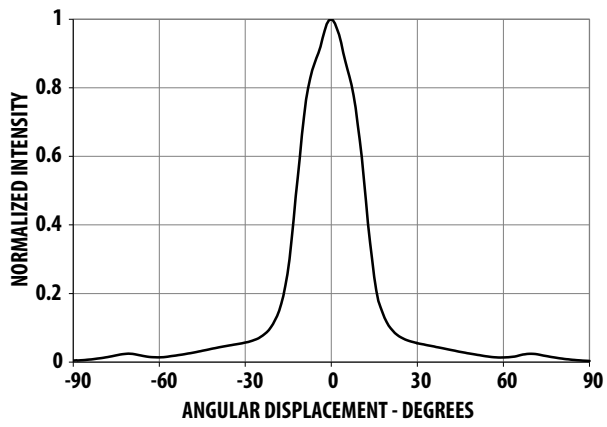

Figure 7. Representative Radiation Pattern for 23° Lamp

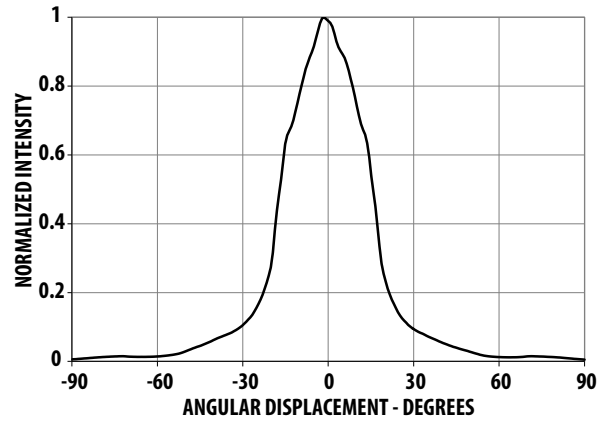

Figure 8. Representative Radiation Pattern for 30° Lamp

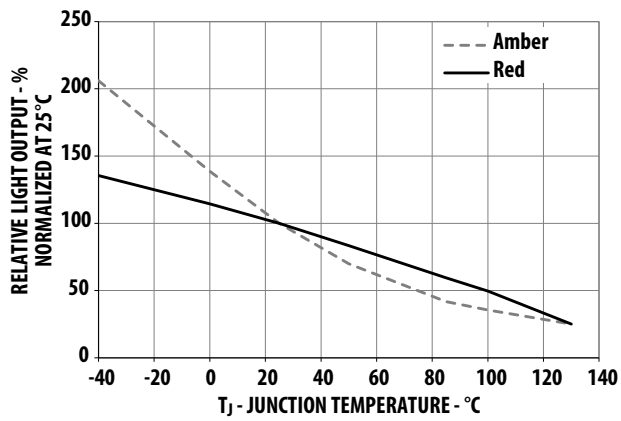

Figure 9. Relative Light Output vs Junction Temperature

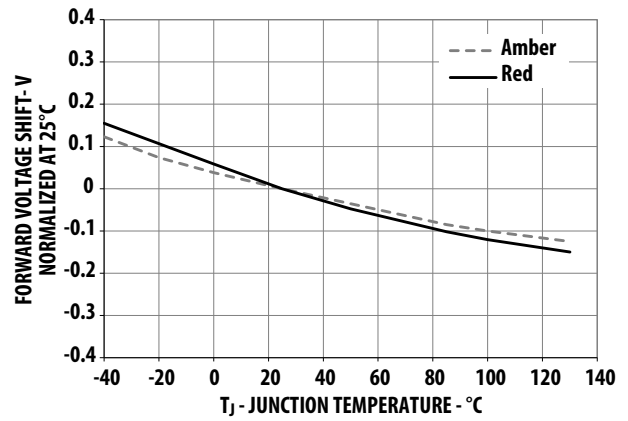

Figure 10. Forward Voltage Shift vs Junction Temperature

### Intensity Bin Limit Table (1.3 : 1 Iv Bin Ratio)

Bin	Intensity (mcd) at 20 mA	
	Min	Max
V	4200	5500
W	5500	7200
X	7200	9300
Y	9300	12000
Z	12000	16000
1	16000	21000

Tolerance for each bin limit is  $\pm 15\%$

### V<sub>F</sub> Bin Table (V at 20 mA)

Bin ID	Min	Max
VD	1.8	2.0
VA	2.0	2.2
VB	2.2	2.4

Tolerance for each bin limit is  $\pm 0.05$  V

### Red Color Range

Min Dom	Max Dom	X min	Y Min	X max	Y max
618.0	630.0	0.6872	0.3126	0.6890	0.2943
		0.6690	0.3149	0.7080	0.2920

Tolerance for each bin limit is  $\pm 0.5$  nm

### Amber Color Range

Bin	Min Dom	Max Dom	Xmin	Ymin	Xmax	Ymax
2	587.0	589.5	0.5570	0.4420	0.5670	0.4250
			0.5530	0.4400	0.5720	0.4270
4	589.5	592.0	0.5720	0.4270	0.5820	0.4110
			0.5670	0.4250	0.5870	0.4130
6	592.0	594.5	0.5870	0.4130	0.5950	0.3980
			0.5820	0.4110	0.6000	0.3990

Tolerance for each bin limit is  $\pm 0.5$  nm

Note:

All bin categories are established for classification of products. Products may not be available in all bin categories. Please contact your Avago representative for further information.

### Avago Color Bin on CIE 1931 Chromaticity Diagram

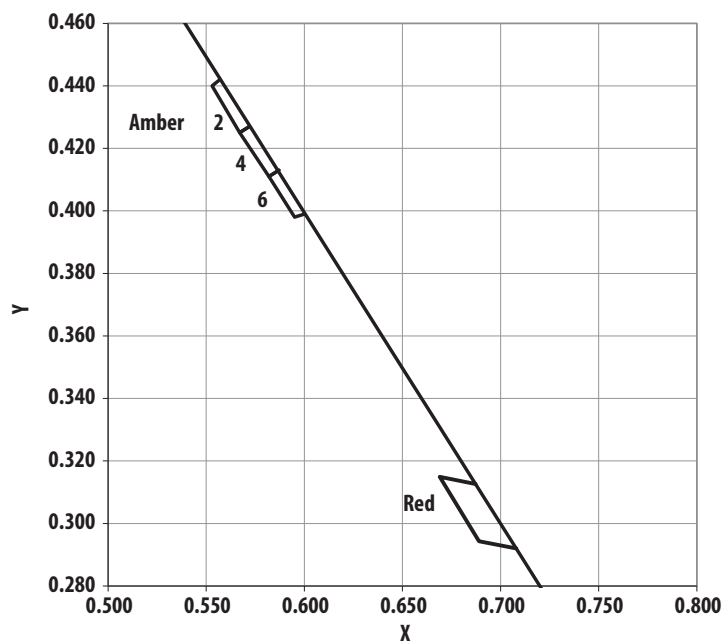



## Precautions:

### Lead Forming:

- The leads of an LED lamp may be preformed or cut to length prior to insertion and soldering on PC board.
- For better control, it is recommended to use proper tool to precisely form and cut the leads to applicable length rather than doing it manually.
- If manual lead cutting is necessary, cut the leads after the soldering process. The solder connection forms a mechanical ground which prevents mechanical stress due to lead cutting from traveling into LED package. This is highly recommended for hand solder operation, as the excess lead length also acts as small heat sink.

### Soldering and Handling:

- Care must be taken during PCB assembly and soldering process to prevent damage to the LED component.
- LED component may be effectively hand soldered to PCB. However, it is only recommended under unavoidable circumstances such as rework. The closest manual soldering distance of the soldering heat source (soldering iron's tip) to the body is 1.59mm. Soldering the LED using soldering iron tip closer than 1.59mm might damage the LED.



- ESD precaution must be properly applied on the soldering station and personnel to prevent ESD damage to the LED component that is ESD sensitive. Do refer to Avago application note AN 1142 for details. The soldering iron used should have grounded tip to ensure electrostatic charge is properly grounded.
- Recommended soldering condition:

	Wave Soldering [1, 2]	Manual Solder Dipping
Pre-heat temperature	105 °C Max.	-
Preheat time	60 sec Max	-
Peak temperature	260 °C Max.	260 °C Max.
Dwell time	5 sec Max.	5 sec Max

Note:

- 1) Above conditions refers to measurement with thermocouple mounted at the bottom of PCB.
  - 2) It is recommended to use only bottom preheaters in order to reduce thermal stress experienced by LED.
- Wave soldering parameters must be set and maintained according to the recommended temperature and dwell time. Customer is advised to perform daily check on the soldering profile to ensure that it is always conforming to recommended soldering conditions.

Note:

1. PCB with different size and design (component density) will have different heat mass (heat capacity). This might cause a change in temperature experienced by the board if same wave soldering setting is used. So, it is recommended to re-calibrate the soldering profile again before loading a new type of PCB.
2. Avago Technologies' high brightness LED are using high efficiency LED die with single wire bond as shown below. Customer is advised to take extra precaution during wave soldering to ensure that the maximum wave temperature does not exceed 260°C and the solder contact time does not exceeding 5sec. Over-stressing the LED during soldering process might cause premature failure to the LED due to delamination.

### Avago Technologies LED Configuration

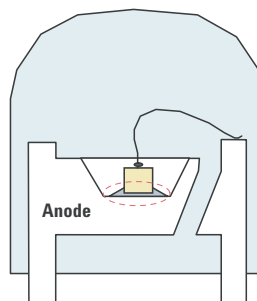

Note: Electrical connection between bottom surface of LED die and the lead frame is achieved through conductive paste.

- Any alignment fixture that is being applied during wave soldering should be loosely fitted and should not apply weight or force on LED. Non metal material is recommended as it will absorb less heat during wave soldering process.

Note: In order to further assist customer in designing jig accurately that fit Avago Technologies' product, 3D model of the product is available upon request.

- At elevated temperature, LED is more susceptible to mechanical stress. Therefore, PCB must allowed to cool down to room temperature prior to handling, which includes removal of alignment fixture or pallet.
- If PCB board contains both through hole (TH) LED and other surface mount components, it is recommended that surface mount components be soldered on the top side of the PCB. If surface mount need to be on the bottom side, these components should be soldered using reflow soldering prior to insertion the TH LED.
- Recommended PC board plated through holes (PTH) size for LED component leads.

LED component lead size	Diagonal	Plated through hole diameter
0.45 x 0.45 mm (0.018x 0.018 inch)	0.636 mm (0.025 inch)	0.98 to 1.08 mm (0.039 to 0.043 inch)
0.50 x 0.50 mm (0.020x 0.020 inch)	0.707 mm (0.028 inch)	1.05 to 1.15 mm (0.041 to 0.045 inch)

- Over-sizing the PTH can lead to twisted LED after clinching. On the other hand under sizing the PTH can cause difficulty inserting the TH LED.

Refer to application note AN5334 for more information about soldering and handling of high brightness TH LED lamps.

### Example of Wave Soldering Temperature Profile for TH LED

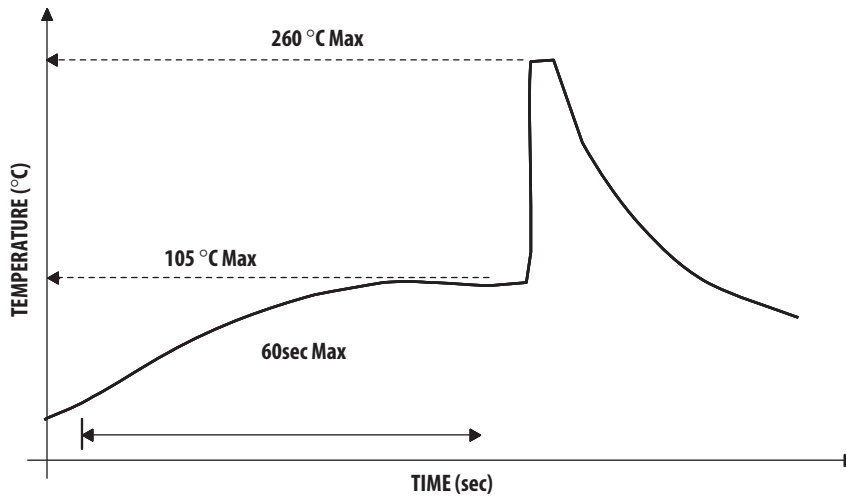

Recommended solder:  
 Sn63 (Leaded solder alloy)  
 SAC305 (Lead free solder alloy)

Flux: Rosin flux

Solder bath temperature: 255°C ± 5°C  
 (maximum peak temperature = 260°C)

Dwell time: 3.0 sec - 5.0 sec  
 (maximum = 5sec)

Note: Allow for board to be sufficiently cooled to room temperature before exerting mechanical force.

### Ammo Packs Drawing

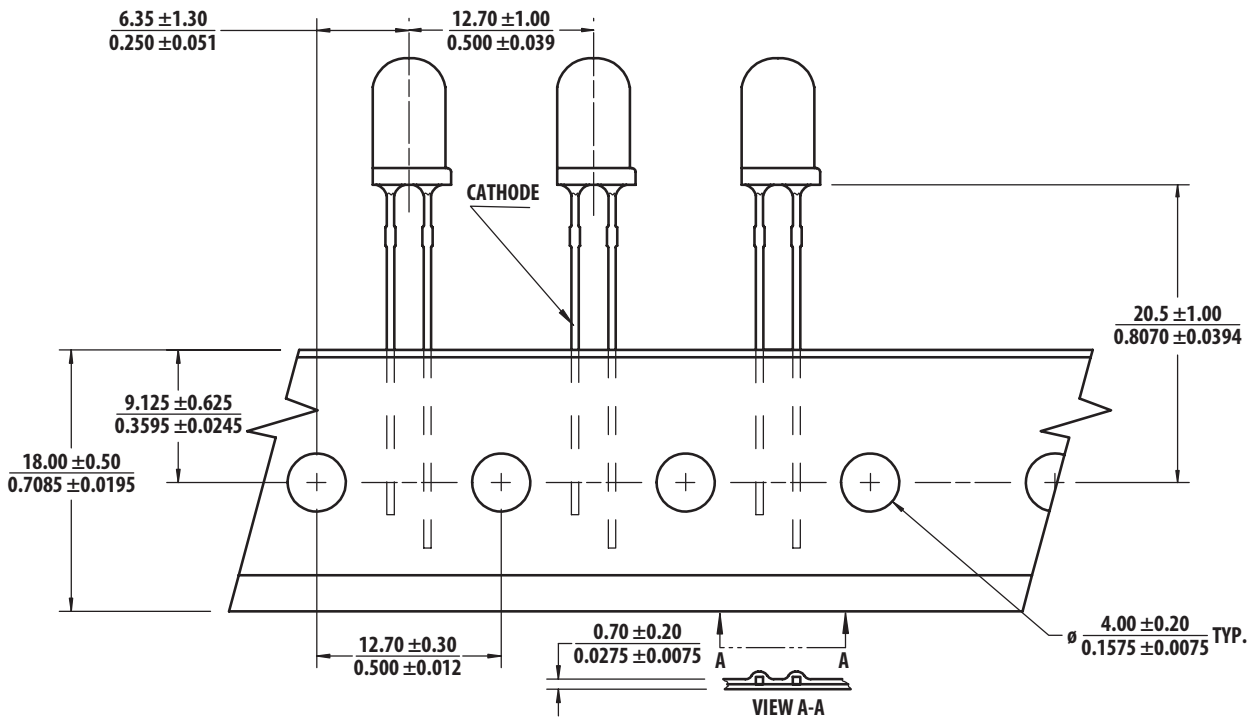

Note: The ammo-packs drawing is applicable for packaging option -DD & -ZZ and regardless standoff or non-standoff

## Packaging Box for Ammo Packs

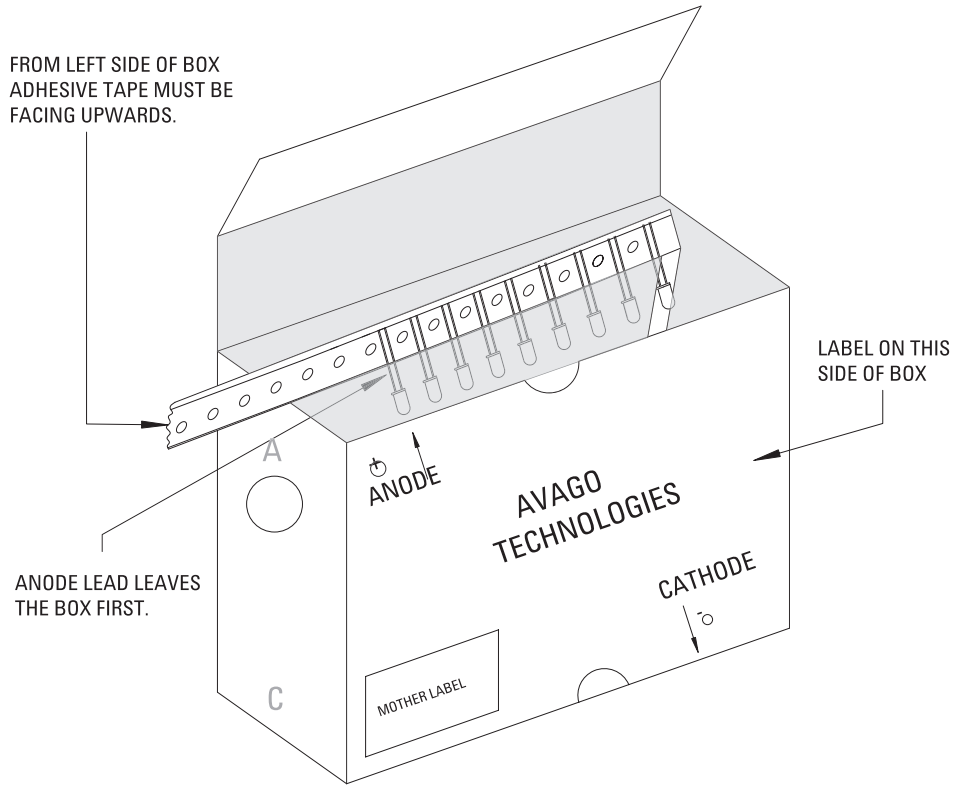











Note: The dimension for ammo pack is applicable for the device with standoff and without standoff.

## Packaging Label:

(i) Avago Mother Label: (Available on packaging box of ammo pack and shipping box)

<b>AVAGO</b> TECHNOLOGIES	
STANDARD LABEL LS0002 RoHS Compliant e3 max temp 260C	
(1P) Item: <b>Part Number</b> [Barcode]	(Q) QTY: <b>Quantity</b> [Barcode]
(1T) Lot: <b>Lot Number</b> [Barcode]	CAT: <b>Intensity Bin</b> [Barcode]
LPN: [Barcode]	BIN: <b>Refer to below information</b>
(9D)MFG Date: <b>Manufacturing Date</b> [Barcode]	
(P) Customer Item: [Barcode]	
(V) Vendor ID: [Barcode]	(9D) Date Code: <b>Date Code</b> [Barcode]
DeptID: [Barcode]	Made In: <b>Country of Origin</b> [Barcode]

**(ii) Avago Baby Label (Only available on bulk packaging)**

 <b>Avago</b> TECHNOLOGIES		RoHS Compliant e3 max temp 260C
<b>Lamps Baby Label</b>		
(1P) PART #: Part Number		
		
(1T) LOT #: Lot Number		
		
(9D)MFG DATE: Manufacturing Date	QUANTITY: Packing Quantity	
		
C/O: Country of Origin		
Customer P/N:	CAT: Intensity Bin	
		
Supplier Code:	BIN: Refer to below information	
		
	DATECODE: Date Code	
		

**Acronyms and Definition:**

BIN:

(i) Color bin only or VF bin only

(Applicable for part number with color bins but without VF bin OR part number with VF bins and no color bin)

OR

(ii) Color bin incorporated with VF Bin

(Applicable for part number that have both color bin and VF bin)

Example:

(i) Color bin only or VF bin only

BIN: 2 (represent color bin 2 only)

BIN: VB (represent VF bin "VB" only)

(ii) Color bin incorporate with VF Bin

BIN: 2 VB

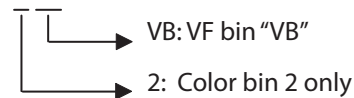

**DISCLAIMER:** Avago's products and software are not specifically designed, manufactured or authorized for sale as parts, components or assemblies for the planning, construction, maintenence or direct operation of a nuclear facility or for use in medical devices or applications. Customer is solely responsible, and waives all rights to make claims against Avago or its suppliers, for all loss, damage, expense or liability in connection with such use.

For product information and a complete list of distributors, please go to our web site: [www.avagotech.com](http://www.avagotech.com)

Avago, Avago Technologies, and the A logo are trademarks of Avago Technologies in the United States and other countries. Data subject to change. Copyright © 2005-2015 Avago Technologies. All rights reserved. AV02-4951EN - June 17, 2015

